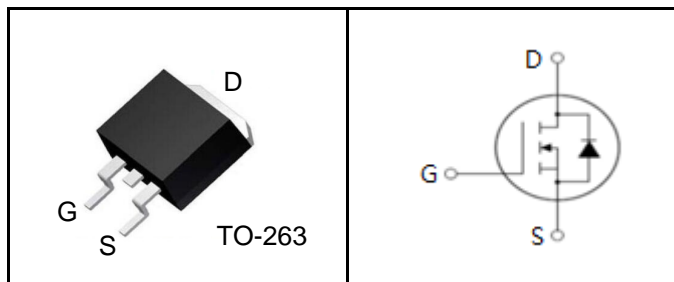


## FEATURES

- $BV_{DSS}=200V$ ,  $I_D=80A$
- $R_{DS(on)}:17m\Omega$  (Max) @  $V_{GS}=10V$
- Very low FOM  $R_{DS(on)} \times Q_g$
- 100% avalanche tested
- RoHS compliant

## APPLICATIONS

- Switch Mode Power Supply (SMPS)
- Uninterruptible Power Supply (UPS)
- High-Frequency Switching and Synchronous Rectification



## Device Marking and Package Information

Device	Package	Marking
MPGC20R170	TO-263	MPGC20R170

## Absolute Maximum Ratings $T_C = 25^\circ C$ , unless otherwise noted

Parameter	Symbol	Value	Unit
Drain-Source Voltage ( $V_{GS} = 0V$ )	$V_{DSS}$	200	V
Continuous Drain Current	$I_D$	80	A
Pulsed Drain Current (note1)	$I_{DM}$	320	A
Gate-Source Voltage	$V_{GSS}$	$\pm 20$	V
Single Pulse Avalanche Energy (note2)	$E_{AS}$	1200	mJ
Power Dissipation ( $T_C = 25^\circ C$ )	$P_D$	300	W
Operating Junction and Storage Temperature Range	$T_J, T_{stg}$	-55~+175	$^\circ C$

## Thermal Resistance

Parameter	Symbol	Value	Unit
Thermal Resistance, Junction-to-Case Max	$R_{thJC}$	0.5	K/W
Thermal Resistance, Junction-to-Ambient	$R_{thJA}$	62	



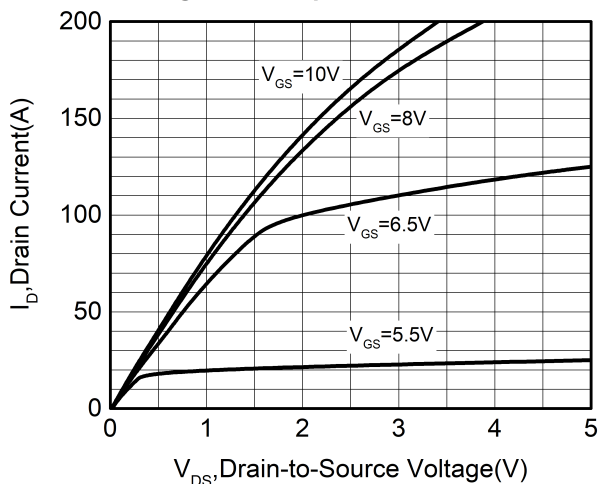
Specifications $T_J = 25^\circ\text{C}$ , unless otherwise noted						
Parameter	Symbol	Test Conditions	Value			Unit
			Min.	Typ.	Max.	
<b>Static</b>						
Drain-Source Breakdown Voltage	$V_{(BR)DSS}$	$V_{GS} = 0V, I_D = 250\mu A$	200	--	--	V
Zero Gate Voltage Drain Current	$I_{DSS}$	$V_{DS} = 200V, V_{GS} = 0V, T_J = 25^\circ\text{C}$	--	--	1	$\mu A$
		$V_{DS} = 200V, V_{GS} = 0V, T_J = 125^\circ\text{C}$	--	--	100	
Gate-Source Leakage	$I_{GSS}$	$V_{GS} = \pm 20V$	--	--	$\pm 100$	nA
Gate-Source Threshold Voltage	$V_{GS(th)}$	$V_{DS} = V_{GS}, I_D = 250\mu A$	2.5	--	4.5	V
Drain-Source On-Resistance (Note3)	$R_{DS(on)}$	$V_{GS} = 10V, I_D = 50A$	--	12	17	m $\Omega$
Gate Resistance	$R_G$	$f = 1.0\text{MHz}$ , open drain	--	3.2	--	$\Omega$
<b>Dynamic</b>						
Input Capacitance	$C_{iss}$	$V_{GS} = 0V,$ $V_{DS} = 50V,$ $f = 1.0\text{MHz}$	--	4543	--	pF
Output Capacitance	$C_{oss}$		--	523	--	
Reverse Transfer Capacitance	$C_{rss}$		--	9	--	
Total Gate Charge	$Q_g$	$V_{DD} = 100V, I_D = 40A,$ $V_{GS} = 10V$	--	57	--	nC
Gate-Source Charge	$Q_{gs}$		--	19	--	
Gate-Drain Charge	$Q_{gd}$		--	9	--	
Turn-on Delay Time	$t_{d(on)}$	$V_{DD} = 100V, I_D = 40A,$ $V_{GS} = 10V, R_G = 2\Omega$	--	15	--	ns
Turn-on Rise Time	$t_r$		--	26	--	
Turn-off Delay Time	$t_{d(off)}$		--	40	--	
Turn-off Fall Time	$t_f$		--	11	--	
<b>Drain-Source Body Diode Characteristics</b>						
Continuous Body Diode Current	$I_S$	$T_C = 25^\circ\text{C}$	--	--	80	A
Pulsed Diode Forward Current	$I_{SM}$		--	--	320	
Body Diode Voltage	$V_{SD}$	$T_J = 25^\circ\text{C}, I_{SD} = 50A, V_{GS} = 0V$	--	0.9	1.2	V
Reverse Recovery Time	$t_{rr}$	$V_R = 100V, I_F = 40A,$ $di_F/dt = 100A/\mu s$	--	125	--	ns
Reverse Recovery Charge	$Q_{rr}$		--	0.55	--	$\mu C$
Peak Reverse Recovery Current	$I_{rrm}$		--	8	--	A

**Notes**

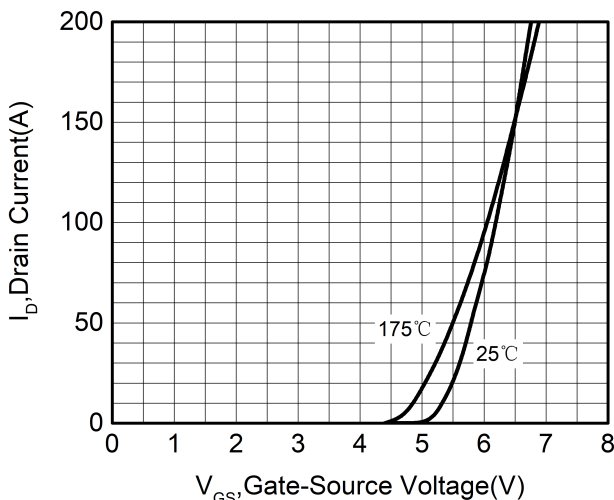
1. Repetitive Rating: Pulse width limited by maximum junction temperature
2.  $L=5\text{mH}, V_{DD} = 50V, R_G = 25\Omega$ , Starting  $T_J = 25^\circ\text{C}$
3. Pulse Test: Pulse width  $\leq 300\mu s$ , Duty Cycle  $\leq 1\%$

**Typical Characteristics**  $T_J = 25^\circ\text{C}$ , unless otherwise noted

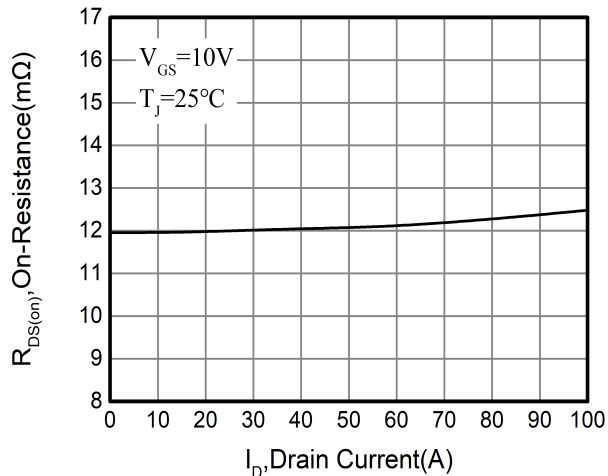
**Figure 1. Output Characteristics**



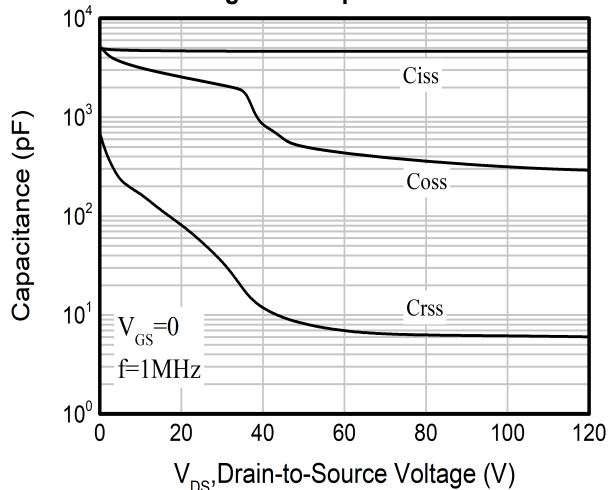
**Figure 2. Transfer Characteristics**



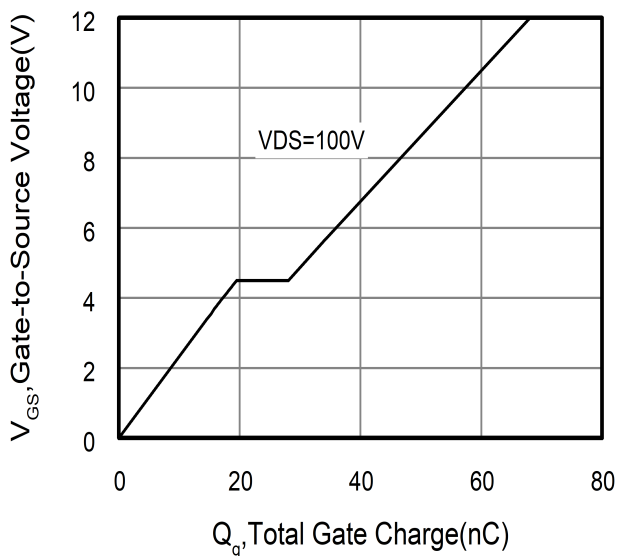
**Figure 3. On-Resistance vs Drain Current**



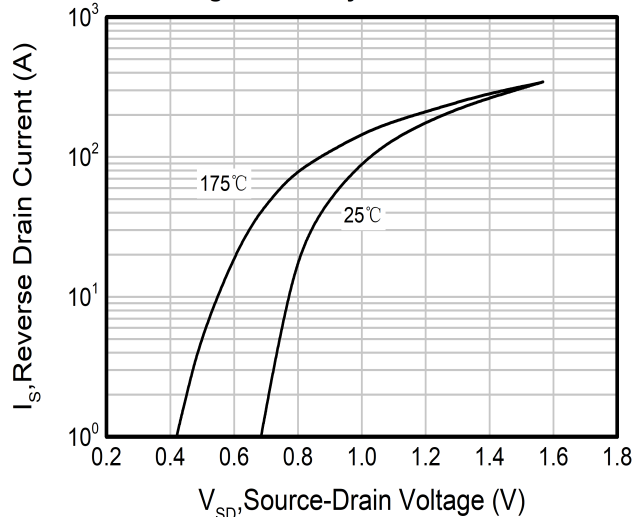
**Figure 4. Capacitance**



**Figure 5. Gate Charge**



**Figure 6. Body Diode Forward**





## Typical Characteristics $T_J = 25^\circ\text{C}$ , unless otherwise noted

Figure 7. On-Resistance vs Junction Temperature

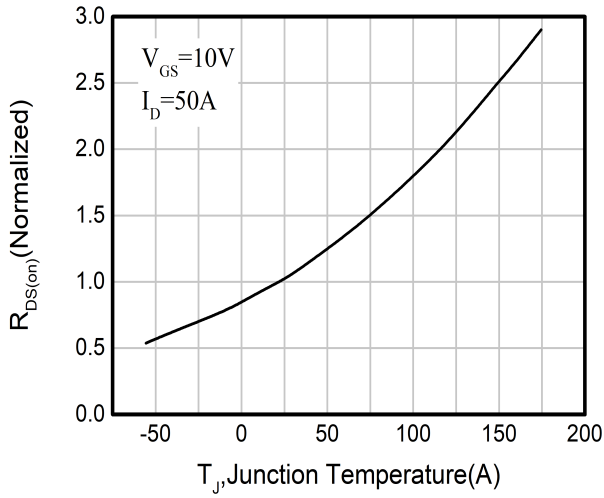


Figure 8. Threshold Voltage vs Junction Temperature

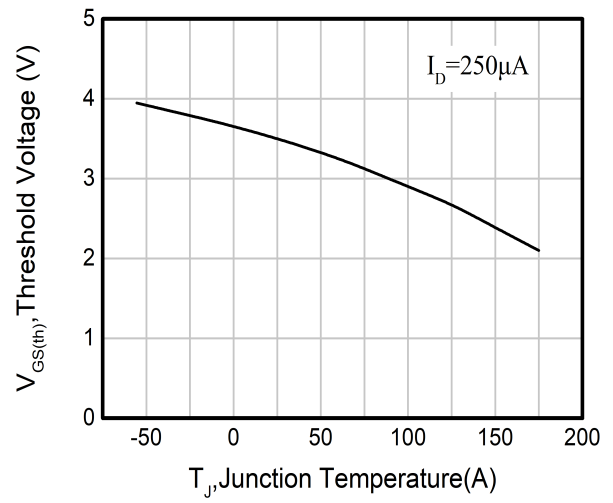


Figure 9. Transient thermal Impedance

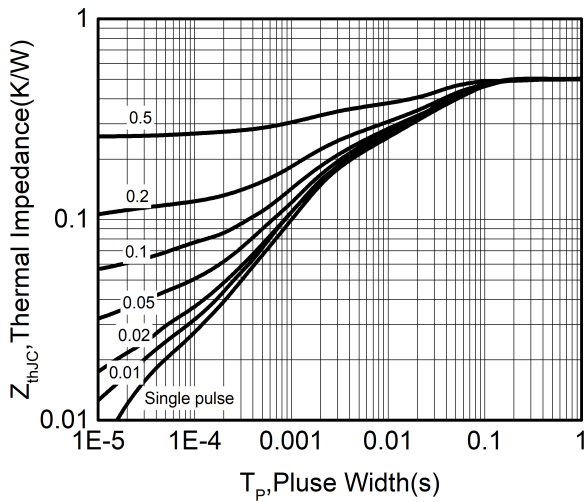
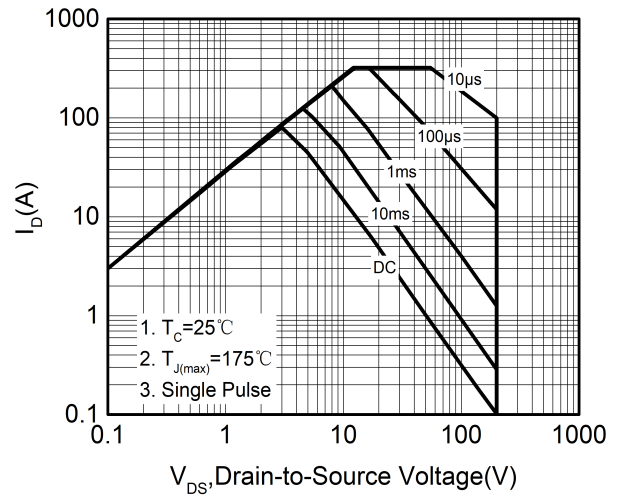
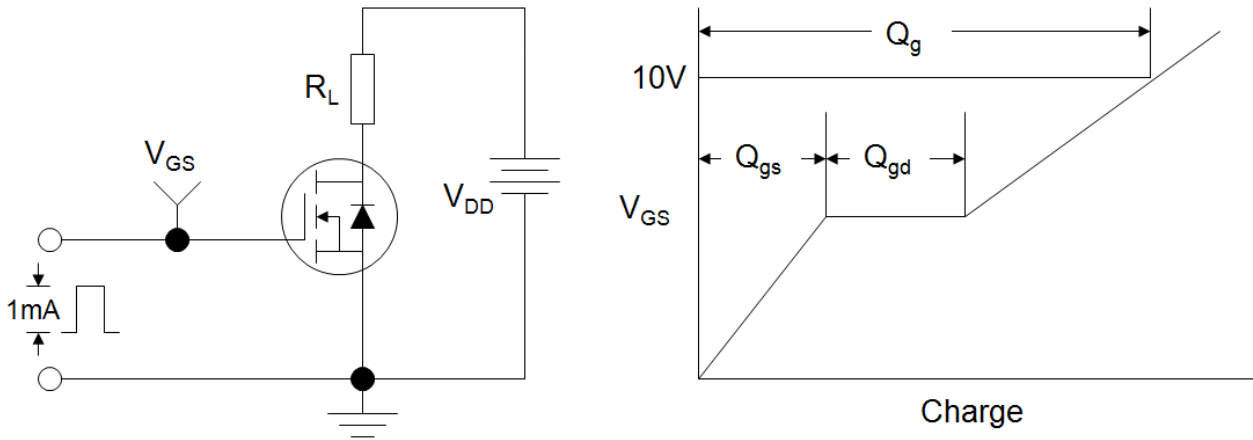


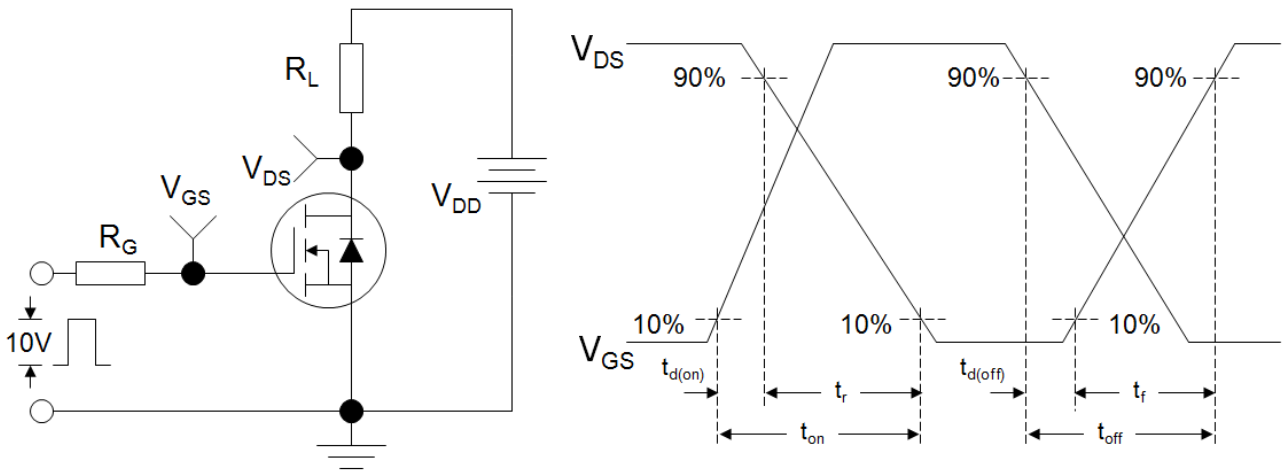
Figure 10. Safe Operating Area



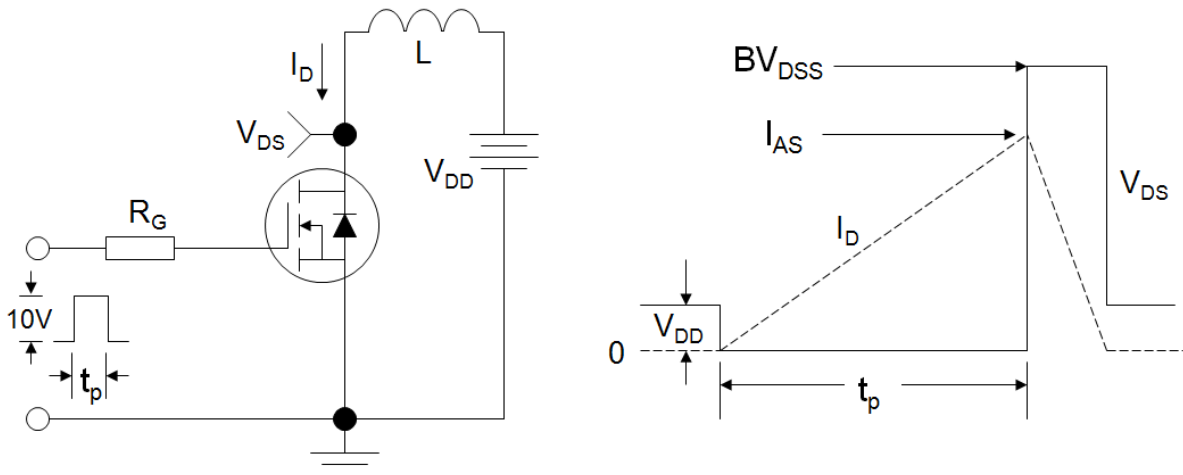
**Figure A: Gate Charge Test Circuit and Waveform**



**Figure B: Resistive Switching Test Circuit and Waveform**

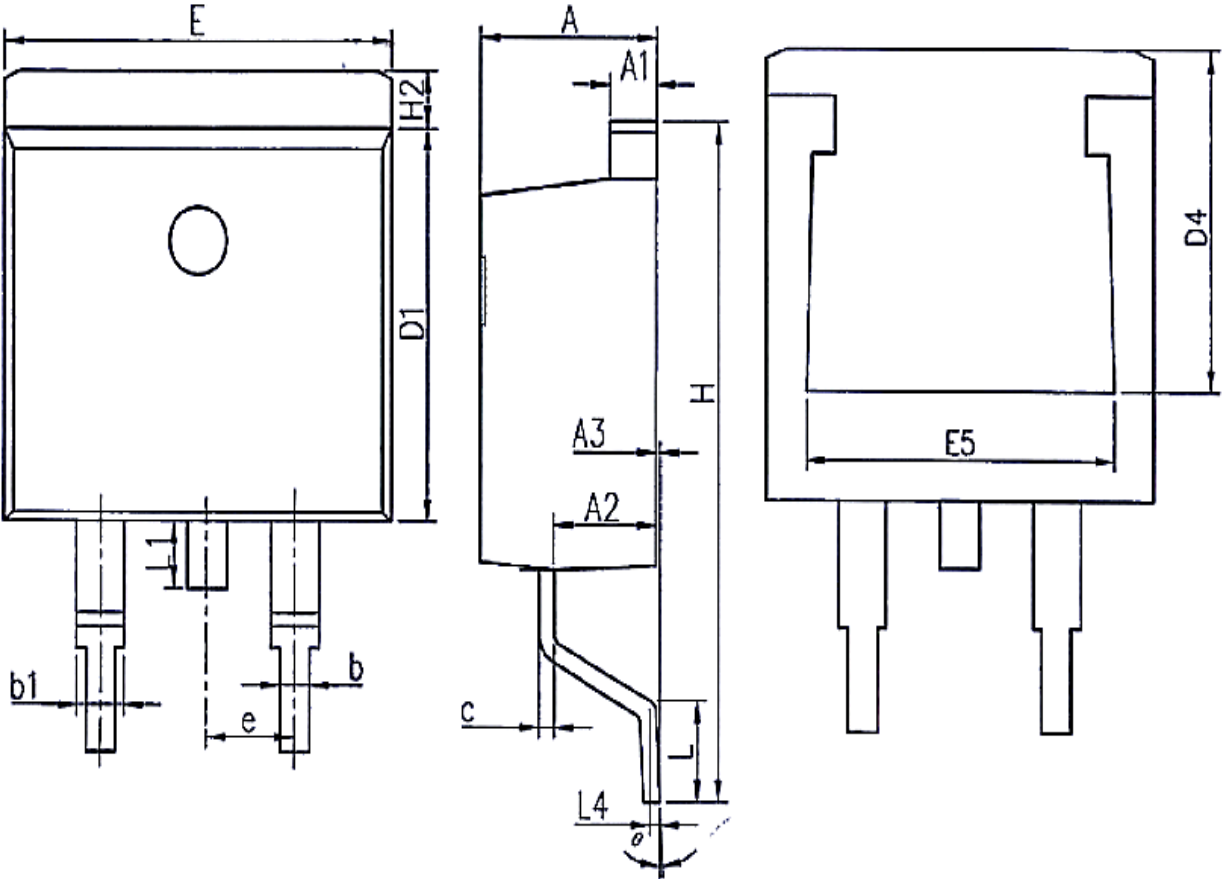


**Figure C: Unclamped Inductive Switching Test Circuit and Waveform**



## Package Dimension

unit: mm



Unit:mm			
Symbol	Min.	Nom	Max.
A	4.37	4.57	4.77
A1	1.22	1.27	1.42
A2	2.49	2.69	2.89
A3	0.00	0.13	0.25
b	0.70	0.81	0.96
b1	1.17	1.27	1.47
c	0.30	0.38	0.53
D1	8.50	8.70	8.90
D4	6.60	-	-

Unit:mm			
Symbol	Min.	Nom	Max.
E	9.86	10.16	10.36
E5	7.06	-	-
e	2.54BSC		
H	14.70	15.10	15.50
H2	1.07	1.27	1.47
L	2.00	2.30	2.60
L1	1.40	1.55	1.70
L4	0.25BSC		
θ	0°	5°	9°

**PIN Connections**  
 1. Gate  
 2. Drain  
 3. Source